

Flanges & Fittings

Section Two



2.1 Chain Clamp Components & Hardware

2.2 NW Flanges & Fittings

2.3 ISO Flanges & Fittings

2.4 ASA Flanges & Fittings

2.5 CF Flanges & Fittings

2.6 Wire Seal Flanges

2.7 Adapter Fittings

2.8 Flexible Hoses & Couplings

2

2.9 Weld Fittings

Nor-Cal Products, Inc.
1967 South Oregon Street
Yreka, CA 96097 USA

Tel: **800-824-4166**
or 530-842-4457
Main Fax: 530-842-9130
Sales Fax: 530-841-9189
www.n-c.com



Flexible Hoses & Couplings

General Information



SPECIFICATIONS

Nominal ID sizes

Bellows: 3/4 to 4 inch (19.05-101.6mm)

PVC Hose: 1/2 to 2 inch (12.7-50.8mm)

Flex Couplings: 3/8 to 12 inch
(9.53-304.8mm)

Flange Types: NW, ISO, CF, ASA

Materials

Bellows: 316L or 321 stainless steel

PVC Hose: Wire reinforced polyvinylchloride

Flanges: 304 stainless steel
(316L available on request)

Vacuum Range

Metal seal: $\geq 1 \times 10^{-10}$ mbar - UHV

Elastomer seal: $\geq 1 \times 10^{-8}$ mbar - High vacuum

PVC Hose: $\geq 1 \times 10^{-2}$ Rough vacuum

Temperature Range

Metal seal: -200°C to 450°C

Elastomer seal: -20°C to 150°C

PVC Hose: -4°C to 65°C

Options: Protective braided sleeving

Flexible Vacuum Connections

Flexible vacuum connections are typically made by using edge welded bellows, hydroformed flexible couplings and hoses or PVC hoses. Edge welded bellows provide the greatest stroke and flexibility, but are the most susceptible to damage. Edge welded bellows are also more expensive than the other flexible connections. Nor-Cal Products offers flexible couplings and flexible hoses as standards. Edge welded bellows assemblies can be provided in a variety of materials as specials. PVC hose offers a low cost alternative to stainless steel flexible hoses.

Flexible Hoses

Flexible stainless steel hoses are available in 3/4 to 4 inch (19.05-101.6mm) diameters in standard lengths of 12, 18, 24 and 36 inches (304.8, 457.2, 609.6 and 914.4mm) with NW, ISO, CF and ASA flanges. Hoses with NW and ISO flanges are also available in 10, 20 and 40 inch (metric equivalent) lengths. CF and ASA flanged hoses have one rotatable and one nonrotatable flange for ease of bolt hole alignment. ASA flanged hoses may require an O-ring groove on one flange for proper installation. Be sure to specify. NW to CF adapter hoses provide a flexible transition between components with NW and CF flanges. NW hoses are available in medium wall "FH-" (0.010 Inch (.254mm) wall thickness), heavy wall "TH-" (0.017 Inches (.432mm)), and thin wall "LH-" (0.006 Inches (.152mm)). Thin wall hose is the perfect choice for applications requiring increased flexibility. Protective braiding is offered as a standard for NW and CF medium wall tubing "FHB-" in diameters up to and including 4 inches (101.6mm).



Flexible Couplings

Pressurizing the inside of thin wall stainless steel tubing inside a mold forms convolutions in flexible couplings and hoses. Generally speaking, when comparing flexible couplings to hoses, they are thinner walled, have more convolutions per inch resulting in greater flexibility and stroke, and are used for alignment or vibration isolation rather than as roughing lines. Being thinner, flexible couplings are more susceptible to mechanical damage than hoses. Nor-Cal's flexible couplings have more convolutions than comparable products, resulting in greater flexibility and lower spring rates. Maximum compression for flexible couplings is typically 20% of the convolution (flexible) length. Extension is typically 10%. Couplings are available in 321 or 316L stainless steel in various lengths with NW, ISO, CF and ASA flanges.

PVC Hoses

Plasticized PVC hoses can be used as a low cost rough vacuum line. An embedded spiral wire prevents the wall from collapsing under vacuum. Unlike edge welded bellows, flexible couplings and hoses, which are UHV compatible, PVC hoses should be used for rough vacuum due to their higher outgassing rate. Although it can be bent relatively easily, it cannot be compressed or extended. Order by the foot with or without NW flanges. Each length includes two hose clamps for installation.

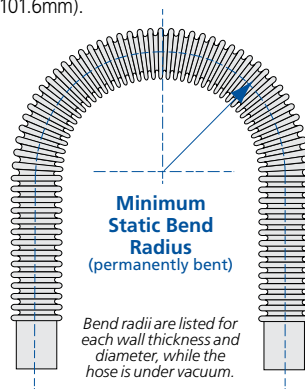

All dimensions are in inches (mm) & weights are in pounds (kg), unless otherwise noted. Spring rates are called out in pounds/inch



NW Flexible Couplings



MODEL NUMBER	FLANGE TYPE	BELLOWS ID	WALL THICKNESS	FREE LENGTH	SPRING RATE	COMPRESSED LENGTH
2FC-NW-10-1	NW-10	3/8 (9.53)	0.008 (.20)	3.30 (83.82)	35	3.0 (76.20)
2FC-NW-10-2	NW-10	3/8 (9.53)	0.008 (.20)	3.80 (96.52)	28	3.4 (86.36)
2FC-NW-10-3	NW-10	3/8 (9.53)	0.008 (.20)	4.80 (121.92)	22	4.2 (106.68)
2FC-NW-16-1	NW-16	1/2 (12.70)	0.005 (.13)	3.20 (81.28)	61	3.0 (76.20)
2FC-NW-16-2	NW-16	1/2 (12.70)	0.005 (.13)	4.20 (106.68)	49	3.8 (96.52)
2FC-NW-16-3	NW-16	1/2 (12.70)	0.005 (.13)	5.20 (132.08)	38	4.6 (116.84)
2FC-NW-25-1	NW-25	3/4 (19.05)	0.006 (.15)	3.20 (81.28)	45	3.0 (76.20)
2FC-NW-25-2	NW-25	3/4 (19.05)	0.006 (.15)	4.20 (106.68)	36	3.8 (96.52)
2FC-NW-25-3	NW-25	3/4 (19.05)	0.006 (.15)	5.20 (132.08)	28	4.6 (116.84)
2FC-NW-40-1	NW-40	1 1/2 (38.10)	0.006 (.15)	3.20 (81.28)	85	3.0 (76.20)
2FC-NW-40-2	NW-40	1 1/2 (38.10)	0.006 (.15)	4.20 (106.68)	69	3.8 (96.52)
2FC-NW-40-3	NW-40	1 1/2 (38.10)	0.006 (.15)	5.20 (132.08)	53	4.6 (116.84)
2FC-NW-40-6	NW-40	1 1/2 (38.10)	0.006 (.15)	8.20 (208.28)	28	7.0 (177.80)
2FC-NW-50-1	NW-50	1 3/4 (44.45)	0.006 (.15)	3.20 (81.28)	62	3.0 (76.20)
2FC-NW-50-2	NW-50	1 3/4 (44.45)	0.006 (.15)	4.20 (106.68)	50	3.8 (96.52)
2FC-NW-50-3	NW-50	1 3/4 (44.45)	0.006 (.15)	5.20 (132.08)	38	4.6 (116.84)

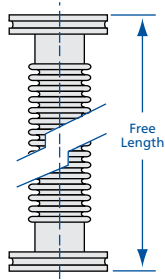
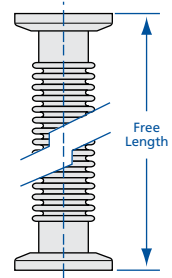

ISO Flexible Couplings

MODEL NUMBER	FLANGE TYPE	BELLOWS ID	WALL THICKNESS	FREE LENGTH	SPRING RATE	COMPRESSED LENGTH
2FC-ISO-250-4	ISO-63	2 1/2 (63.50)	0.008 (.20)	7.00 (177.80)	80	6.20 (157.48)
2FC-ISO-300-4	ISO-80	3 (76.20)	0.008 (.20)	7.00 (177.80)	78	6.20 (157.48)
2FC-ISO-400-4	ISO-100	4 (101.60)	0.010 (.25)	7.00 (177.80)	75	6.20 (157.48)
2FC-ISO-600-4	ISO-160	6 (152.40)	0.010 (.25)	7.00 (177.80)	130	6.20 (157.48)
2FC-ISO-800-4	ISO-200	8 (203.20)	0.010 (.25)	7.00 (177.80)	83	6.20 (157.48)
2FC-ISO-1000-10	ISO-250	10 (254.00)	0.012 (.30)	13.50 (342.90)	87	11.40 (289.56)



ASA Flexible Couplings

MODEL NUMBER	FLANGE TYPE	BELLOWS ID	WALL THICKNESS	FREE LENGTH	SPRING RATE	COMPRESSED LENGTH
2FC-ASA-5-200N-3	ASA 5	2 (50.80)	0.006 (.15)	6.00 (152.40)	56	5.4 (137.16)
2FC-ASA-5-250N-4	ASA 5	2 1/2 (63.50)	0.008 (.20)	7.00 (177.80)	80	6.20 (157.48)
2FC-ASA-6-300N-4	ASA 6	3 (76.20)	0.008 (.20)	7.00 (177.80)	78	6.20 (157.48)
2FC-ASA-7.5-400N-4	ASA 7.5	4 (101.60)	0.008 (.20)	7.00 (177.80)	75	6.20 (157.48)
2FC-ASA-9-400N-4	ASA 9	4 (101.60)	0.008 (.20)	7.00 (177.80)	75	6.20 (157.48)
2FC-ASA-9-600N-4	ASA 9	6 (152.40)	0.010 (.25)	7.00 (177.80)	130	6.20 (157.48)
2FC-ASA-11-600N-4	ASA 11	6 (152.40)	0.010 (.25)	7.00 (177.80)	130	6.20 (157.48)
2FC-ASA-11-800N-4	ASA 11	8 (203.20)	0.010 (.25)	7.00 (177.80)	83	6.20 (157.48)
2FC-ASA-13.5-800N-4	ASA 13.5	8 (203.20)	0.010 (.25)	7.00 (177.80)	83	6.20 (157.48)
2FC-ASA-13.5-1000N-10	ASA 13.5	10 (254.00)	0.012 (.30)	14.00 (355.60)	87	12.0 (304.80)
2FC-ASA-16-1000N-10	ASA 16	10 (254.00)	0.012 (.30)	14.00 (355.60)	87	12.0 (304.80)
2FC-ASA-16-1200N-11.8	ASA 16	12 (304.8)	0.012 (.30)	15.87 (403.10)	92	13.8 (350.52)

Note: Call for ASA O-ring groove pricing

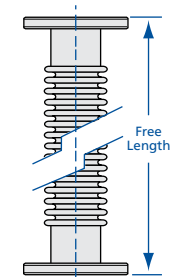

CF Flexible Couplings

MODEL NUMBER	FLANGE TYPE	BELLOWS ID	WALL THICKNESS	FREE LENGTH	SPRING RATE	COMPRESSED LENGTH
2FC-075-1	1.33 CF	1/2 (12.70)	0.005 (.13)	3.20 (81.28)	61	3.0 (76.20)
2FC-075-2	1.33 CF	1/2 (12.70)	0.005 (.13)	4.20 (106.68)	49	3.8 (96.52)
2FC-075-3	1.33 CF	1/2 (12.70)	0.005 (.13)	5.20 (132.08)	38	4.6 (116.84)
2FC-100-1	2.12 CF	3/4 (19.05)	0.006 (.15)	3.20 (81.28)	45	3.0 (76.20)
2FC-100-2	2.12 CF	3/4 (19.05)	0.006 (.15)	4.20 (106.68)	36	3.8 (96.52)
2FC-100-3	2.12 CF	3/4 (19.05)	0.006 (.15)	5.20 (132.08)	28	4.6 (116.84)
2FC-150-1	2.75 CF	1 1/2 (38.10)	0.006 (.15)	3.20 (81.28)	85	3.0 (76.20)
2FC-150-2	2.75 CF	1 1/2 (38.10)	0.006 (.15)	4.20 (106.68)	69	3.8 (96.52)
2FC-150-3	2.75 CF	1 1/2 (38.10)	0.006 (.15)	5.20 (132.08)	53	4.6 (116.84)
2FC-150-6	2.75 CF	1 1/2 (38.10)	0.006 (.15)	8.20 (208.28)	28	7.0 (177.80)
2FC-200-3	3.38 CF	2 (50.80)	0.006 (.15)	6.00 (152.40)	56	5.4 (137.16)
2FC-250-4	4.50 CF	2 1/2 (63.50)	0.008 (.20)	7.00 (177.80)	80	6.2 (157.48)
2FC-300-4	4.62 CF	3 (76.20)	0.008 (.20)	7.00 (177.80)	78	6.2 (157.48)
2FC-400-4	6.00 CF	4 (101.60)	0.008 (.20)	7.00 (177.80)	75	6.2 (157.48)
2FC-500-4	6.75 CF	5 (127.00)	0.008 (.20)	7.00 (177.80)	73	6.2 (157.48)
2FC-600-4	8.00 CF	6 (152.40)	0.010 (.25)	7.00 (177.80)	130	6.2 (157.48)
2FC-800-4	10.00 CF	8 (203.20)	0.010 (.25)	7.00 (177.80)	83	6.2 (157.48)

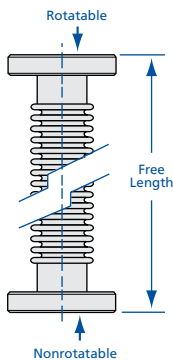

SPECIFICATIONS

Nominal ID sizes: 3/8 to 12 inches (9.53-304.8mm)

Materials

Bellows: 316L or 321 stainless steel
Flanges: 304 stainless steel (316L available on request)

Vacuum Range

Metal seal: ≥1 x 10⁻¹⁰ mbar - UHV
Elastomer seal: ≥1 x 10⁻⁸ mbar - High vacuum

Temperature Range

Metal seal: -200°C to 450°C
Elastomer seal: -20°C to 150°C

All dimensions are in inches (mm) & weights are in pounds (kg), unless otherwise noted.

Flexible Hoses & Couplings

Flexible Stainless Steel Hoses



SPECIFICATIONS

Nominal ID sizes: 3/4 to 4 inch
(19.05-101.6mm)

Materials

Bellows: 321 stainless steel
Tube ends: 304 stainless steel

Vacuum Range: $\geq 1 \times 10^{-10}$ mbar - UHV

Temperature Range: -200°C to 450°C

Options: Protective braided sleeving

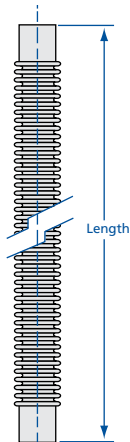

Flexible Stainless Steel Hoses without Flanges

MODEL NUMBER	NOMINAL ID	HOSE OD	OVERALL LENGTH	WALL THICKNESS	STATIC BEND RADIUS
FH-075-12	3/4 (19.05)	1.11 (28.19)	12 (304.80)	0.008 (.20)	1.26 (32.00)
FH-075-18	3/4 (19.05)	1.11 (28.19)	18 (457.20)	0.008 (.20)	1.26 (32.00)
FH-075-24	3/4 (19.05)	1.11 (28.19)	24 (609.60)	0.008 (.20)	1.26 (32.00)
FH-075-36	3/4 (19.05)	1.11 (28.19)	36 (914.40)	0.008 (.20)	1.26 (32.00)
FH-100-12	1 (25.40)	1.37 (34.80)	12 (304.80)	0.008 (.20)	1.46 (37.08)
FH-100-18	1 (25.40)	1.37 (34.80)	18 (457.20)	0.008 (.20)	1.46 (37.08)
FH-100-24	1 (25.40)	1.37 (34.80)	24 (609.60)	0.008 (.20)	1.46 (37.08)
FH-100-36	1 (25.40)	1.37 (34.80)	36 (914.40)	0.008 (.20)	1.46 (37.08)
FH-150-12	1 1/2 (38.10)	2.06 (52.32)	12 (304.80)	0.010 (.25)	2.16 (54.86)
FH-150-18	1 1/2 (38.10)	2.06 (52.32)	18 (457.20)	0.010 (.25)	2.16 (54.86)
FH-150-24	1 1/2 (38.10)	2.06 (52.32)	24 (609.60)	0.010 (.25)	2.16 (54.86)
FH-150-36	1 1/2 (38.10)	2.06 (52.32)	36 (914.40)	0.010 (.25)	2.16 (54.86)
FH-200-12	2 (50.80)	2.55 (64.77)	12 (304.80)	0.012 (.30)	3.50 (88.90)
FH-200-18	2 (50.80)	2.55 (64.77)	18 (457.20)	0.012 (.30)	3.50 (88.90)
FH-200-24	2 (50.80)	2.55 (64.77)	24 (609.60)	0.012 (.30)	3.50 (88.90)
FH-200-36	2 (50.80)	2.55 (64.77)	36 (914.40)	0.012 (.30)	3.50 (88.90)
FH-250-12	2 1/2 (63.50)	3.34 (84.84)	12 (304.80)	0.016 (.41)	4.25 (107.95)
FH-250-18	2 1/2 (63.50)	3.34 (84.84)	18 (457.20)	0.016 (.41)	4.25 (107.95)
FH-250-24	2 1/2 (63.50)	3.34 (84.84)	24 (609.60)	0.016 (.41)	4.25 (107.95)
FH-250-36	2 1/2 (63.50)	3.34 (84.84)	36 (914.40)	0.016 (.41)	4.25 (107.95)
FH-300-12	3 (76.20)	3.99 (101.35)	12 (304.80)	0.016 (.41)	6.00 (152.40)
FH-300-18	3 (76.20)	3.99 (101.35)	18 (457.20)	0.016 (.41)	6.00 (152.40)
FH-300-24	3 (76.20)	3.99 (101.35)	24 (609.60)	0.016 (.41)	6.00 (152.40)
FH-300-36	3 (76.20)	3.99 (101.35)	36 (914.40)	0.016 (.41)	6.00 (152.40)
FH-400-12	4 (101.60)	4.83 (122.68)	12 (304.80)	0.016 (.41)	8.60 (218.44)
FH-400-18	4 (101.60)	4.83 (122.68)	18 (457.20)	0.016 (.41)	8.60 (218.44)
FH-400-24	4 (101.60)	4.83 (122.68)	24 (609.60)	0.016 (.41)	8.60 (218.44)
FH-400-36	4 (101.60)	4.83 (122.68)	36 (914.40)	0.016 (.41)	8.60 (218.44)

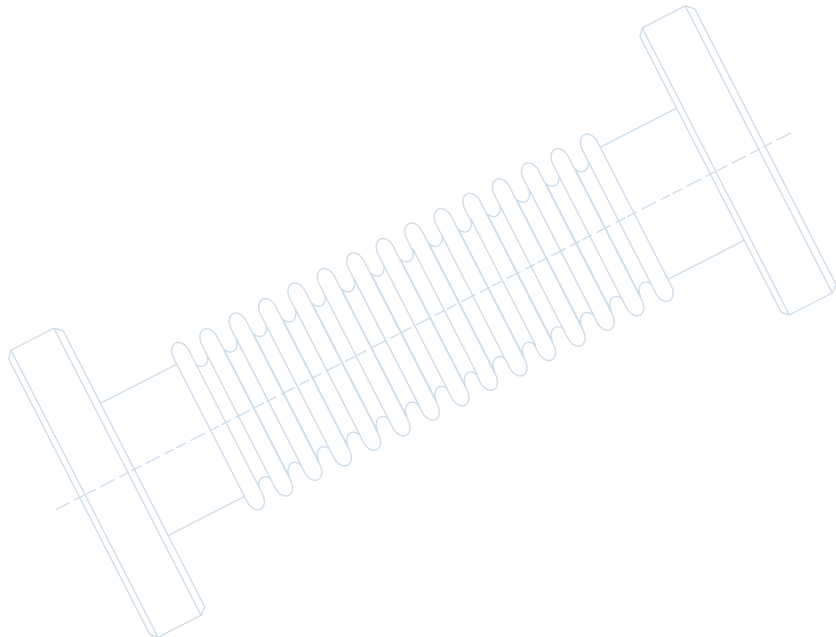

All dimensions are in inches (mm) & weights are in pounds (kg), unless otherwise noted.



NW Flexible Stainless Steel Hoses – Thin Wall

MODEL NUMBER	FLANGE TYPE	NOMINAL ID	HOSE OD	OVERALL LENGTH	WALL THICKNESS	STATIC BEND RADIUS
LH-075-10-2NW	NW-16	3/4 (19.05)	1.02 (25.91)	10 (254.00)	0.006 (.15)	3.0 (76.20)
LH-075-12-2NW	NW-16	3/4 (19.05)	1.02 (25.91)	12 (304.80)	0.006 (.15)	3.0 (76.20)
LH-075-18-2NW	NW-16	3/4 (19.05)	1.02 (25.91)	18 (457.20)	0.006 (.15)	3.0 (76.20)
LH-075-24-2NW	NW-16	3/4 (19.05)	1.02 (25.91)	24 (609.60)	0.006 (.15)	3.0 (76.20)
LH-075-36-2NW	NW-16	3/4 (19.05)	1.02 (25.91)	36 (914.40)	0.006 (.15)	3.0 (76.20)
LH-100-10-2NW	NW-25	1 (25.40)	1.37 (34.80)	10 (254.00)	0.006 (.15)	4.0 (101.60)
LH-100-12-2NW	NW-25	1 (25.40)	1.37 (34.80)	12 (304.80)	0.006 (.15)	4.0 (101.60)
LH-100-18-2NW	NW-25	1 (25.40)	1.37 (34.80)	18 (457.20)	0.006 (.15)	4.0 (101.60)
LH-100-24-2NW	NW-25	1 (25.40)	1.37 (34.80)	24 (609.60)	0.006 (.15)	4.0 (101.60)
LH-100-36-2NW	NW-25	1 (25.40)	1.37 (34.80)	36 (914.40)	0.006 (.15)	4.0 (101.60)
LH-150-10-2NW	NW-40	1 1/2 (38.10)	1.91 (48.51)	10 (254.00)	0.006 (.15)	6.0 (152.40)
LH-150-12-2NW	NW-40	1 1/2 (38.10)	1.91 (48.51)	12 (304.80)	0.006 (.15)	6.0 (152.40)
LH-150-18-2NW	NW-40	1 1/2 (38.10)	1.91 (48.51)	18 (457.20)	0.006 (.15)	6.0 (152.40)
LH-150-24-2NW	NW-40	1 1/2 (38.10)	1.91 (48.51)	24 (609.60)	0.006 (.15)	6.0 (152.40)
LH-150-36-2NW	NW-40	1 1/2 (38.10)	1.91 (48.51)	36 (914.40)	0.006 (.15)	6.0 (152.40)
LH-200-10-2NW	NW-50	2 (50.80)	2.45 (62.23)	10 (254.00)	0.006 (.15)	7.5 (190.50)
LH-200-12-2NW	NW-50	2 (50.80)	2.45 (62.23)	12 (304.80)	0.006 (.15)	7.5 (190.50)
LH-200-18-2NW	NW-50	2 (50.80)	2.45 (62.23)	18 (457.20)	0.006 (.15)	7.5 (190.50)
LH-200-24-2NW	NW-50	2 (50.80)	2.45 (62.23)	24 (609.60)	0.006 (.15)	7.5 (190.50)
LH-200-36-2NW	NW-50	2 (50.80)	2.45 (62.23)	36 (914.40)	0.006 (.15)	7.5 (190.50)

NW Flexible Stainless Steel Hoses – Medium Wall

MODEL NUMBER	FLANGE TYPE	NOMINAL ID	HOSE OD	OVERALL LENGTH	WALL THICKNESS	STATIC BEND RADIUS
FH-075-10-2NW	NW-16	3/4 (19.05)	1.11 (28.19)	10 (254.00)	0.008 (.20)	1.26 (32.00)
FH-075-12-2NW	NW-16	3/4 (19.05)	1.11 (28.19)	12 (304.80)	0.008 (.20)	1.26 (32.00)
FH-075-18-2NW	NW-16	3/4 (19.05)	1.11 (28.19)	18 (457.20)	0.008 (.20)	1.26 (32.00)
FH-075-20-2NW	NW-16	3/4 (19.05)	1.11 (28.19)	20 (508.00)	0.008 (.20)	1.26 (32.00)
FH-075-24-2NW	NW-16	3/4 (19.05)	1.11 (28.19)	24 (609.60)	0.008 (.20)	1.26 (32.00)
FH-075-36-2NW	NW-16	3/4 (19.05)	1.11 (28.19)	36 (914.40)	0.008 (.20)	1.26 (32.00)
FH-075-40-2NW	NW-16	3/4 (19.05)	1.11 (28.19)	40 (1016.00)	0.008 (.20)	1.26 (32.00)
FH-100-10-2NW	NW-25	1 (25.40)	1.37 (34.80)	10 (254.00)	0.008 (.20)	1.46 (37.08)
FH-100-12-2NW	NW-25	1 (25.40)	1.37 (34.80)	12 (304.80)	0.008 (.20)	1.46 (37.08)
FH-100-18-2NW	NW-25	1 (25.40)	1.37 (34.80)	18 (457.20)	0.008 (.20)	1.46 (37.08)
FH-100-20-2NW	NW-25	1 (25.40)	1.37 (34.80)	20 (508.00)	0.008 (.20)	1.46 (37.08)
FH-100-24-2NW	NW-25	1 (25.40)	1.37 (34.80)	24 (609.60)	0.008 (.20)	1.46 (37.08)
FH-100-36-2NW	NW-25	1 (25.40)	1.37 (34.80)	36 (914.40)	0.008 (.20)	1.46 (37.08)
FH-100-40-2NW	NW-25	1 (25.40)	1.37 (34.80)	40 (1016.00)	0.008 (.20)	1.46 (37.08)
FH-150-10-2NW	NW-40	1 1/2 (38.10)	2.06 (52.32)	10 (254.00)	0.010 (.25)	2.16 (54.86)
FH-150-12-2NW	NW-40	1 1/2 (38.10)	2.06 (52.32)	12 (304.80)	0.010 (.25)	2.16 (54.86)
FH-150-18-2NW	NW-40	1 1/2 (38.10)	2.06 (52.32)	18 (457.20)	0.010 (.25)	2.16 (54.86)
FH-150-20-2NW	NW-40	1 1/2 (38.10)	2.06 (52.32)	20 (508.00)	0.010 (.25)	2.16 (54.86)
FH-150-24-2NW	NW-40	1 1/2 (38.10)	2.06 (52.32)	24 (609.60)	0.010 (.25)	2.16 (54.86)
FH-150-36-2NW	NW-40	1 1/2 (38.10)	2.06 (52.32)	36 (914.40)	0.010 (.25)	2.16 (54.86)
FH-150-40-2NW	NW-40	1 1/2 (38.10)	2.06 (52.32)	40 (1016.00)	0.010 (.25)	2.16 (54.86)
FH-200-10-2NW	NW-50	2 (50.80)	2.55 (64.77)	10 (254.00)	0.012 (.30)	3.50 (88.90)
FH-200-12-2NW	NW-50	2 (50.80)	2.55 (64.77)	12 (304.80)	0.012 (.30)	3.50 (88.90)
FH-200-18-2NW	NW-50	2 (50.80)	2.55 (64.77)	18 (457.20)	0.012 (.30)	3.50 (88.90)
FH-200-20-2NW	NW-50	2 (50.80)	2.55 (64.77)	20 (508.00)	0.012 (.30)	3.50 (88.90)
FH-200-24-2NW	NW-50	2 (50.80)	2.55 (64.77)	24 (609.60)	0.012 (.30)	3.50 (88.90)
FH-200-36-2NW	NW-50	2 (50.80)	2.55 (64.77)	36 (914.40)	0.012 (.30)	3.50 (88.90)
FH-200-40-2NW	NW-50	2 (50.80)	2.55 (64.77)	40 (1016.00)	0.012 (.30)	3.50 (88.90)

SPECIFICATIONS

Nominal ID sizes: 3/4 to 2 inch (19.05 -50.8mm)

Materials

Hose: 321 stainless steel
 Tube ends: 304 stainless steel
 Flanges: 304 stainless steel
 (316L available on request)

Vacuum Range

Metal seal: $\geq 1 \times 10^{-10}$ mbar - UHV
 Elastomer seal: $\geq 1 \times 10^{-8}$ mbar - High vacuum

Temperature Range

Metal seal: -200°C to 450°C
 Elastomer seal: -20°C to 150°C

Options: Protective braided sleeving

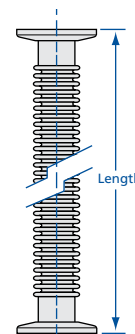

Larger hose IDs and other flange configurations available upon request.

All dimensions are in inches (mm) & weights are in pounds (kg), unless otherwise noted.

Flexible Hoses & Couplings

Flexible Stainless Steel Hoses

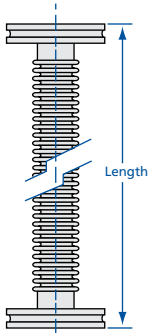
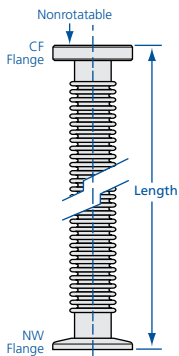
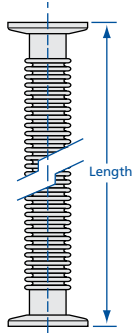

NW Flexible Stainless Steel Hoses – Thick Wall

MODEL NUMBER	FLANGE TYPE	NOMINAL ID	HOSE OD	OVERALL LENGTH	WALL THICKNESS	STATIC BEND RADIUS
TH-075-10-2NW	NW-16	3/4 (19.05)	1.10 (27.94)	10 (254.00)	0.017 (.43)	2.13 (54.10)
TH-075-20-2NW	NW-16	3/4 (19.05)	1.10 (27.94)	20 (508.00)	0.017 (.43)	2.13 (54.10)
TH-075-40-2NW	NW-16	3/4 (19.05)	1.10 (27.94)	40 (1016.00)	0.017 (.43)	2.13 (54.10)
TH-100-10-2NW	NW-25	1 (25.40)	1.50 (38.10)	10 (254.00)	0.017 (.43)	2.88 (73.15)
TH-100-20-2NW	NW-25	1 (25.40)	1.50 (38.10)	20 (508.00)	0.017 (.43)	2.88 (73.15)
TH-100-40-2NW	NW-25	1 (25.40)	1.50 (38.10)	40 (1016.00)	0.017 (.43)	2.88 (73.15)
TH-150-10-2NW	NW-40	1 1/2 (38.10)	2.10 (53.34)	10 (254.00)	0.020 (.51)	3.50 (88.90)
TH-150-20-2NW	NW-40	1 1/2 (38.10)	2.10 (53.34)	20 (508.00)	0.020 (.51)	3.50 (88.90)
TH-150-40-2NW	NW-40	1 1/2 (38.10)	2.10 (53.34)	40 (1016.00)	0.020 (.51)	3.50 (88.90)
TH-200-10-2NW	NW-50	2 (50.80)	2.63 (66.80)	10 (254.00)	0.020 (.51)	5.25 (133.35)
TH-200-20-2NW	NW-50	2 (50.80)	2.63 (66.80)	20 (508.00)	0.020 (.51)	5.25 (133.35)
TH-200-40-2NW	NW-50	2 (50.80)	2.63 (66.80)	40 (1016.00)	0.020 (.51)	5.25 (133.35)

NW/CF Flexible Stainless Steel Adapter Hoses – Medium Wall

MODEL NUMBER	FLANGE 1 TYPE	FLANGE 2 TYPE	NOMINAL ID	HOSE OD	OVERALL LENGTH	WALL THICKNESS	STATIC BEND RADIUS
FH-075-12-NW-CF	NW-16	CF-1.33	3/4 (19.05)	1.11 (28.19)	12 (304.80)	0.008 (.20)	1.26 (32.00)
FH-075-18-NW-CF	NW-16	CF-1.33	3/4 (19.05)	1.11 (28.19)	18 (457.20)	0.008 (.20)	1.26 (32.00)
FH-075-24-NW-CF	NW-16	CF-1.33	3/4 (19.05)	1.11 (28.19)	24 (609.60)	0.008 (.20)	1.26 (32.00)
FH-075-36-NW-CF	NW-16	CF-1.33	3/4 (19.05)	1.11 (28.19)	36 (914.40)	0.008 (.20)	1.26 (32.00)
FH-150-12-NW-CF	NW-40	CF-2.75	1 1/2 (38.10)	2.06 (52.32)	12 (304.80)	0.010 (.25)	2.16 (54.86)
FH-150-18-NW-CF	NW-40	CF-2.75	1 1/2 (38.10)	2.06 (52.32)	18 (457.20)	0.010 (.25)	2.16 (54.86)
FH-150-24-NW-CF	NW-40	CF-2.75	1 1/2 (38.10)	2.06 (52.32)	24 (609.60)	0.010 (.25)	2.16 (54.86)
FH-150-36-NW-CF	NW-40	CF-2.75	1 1/2 (38.10)	2.06 (52.32)	36 (914.40)	0.010 (.25)	2.16 (54.86)

ISO Flexible Stainless Steel Hoses – Medium Wall

MODEL NUMBER	FLANGE TYPE	NOMINAL ID	HOSE OD	OVERALL LENGTH	WALL THICKNESS	STATIC BEND RADIUS
FH-250-10-2ISO	ISO-63	2 1/2 (63.50)	3.34 (84.84)	10 (254.00)	0.016 (.41)	3.15 (80.01)
FH-250-12-2ISO	ISO-63	2 1/2 (63.50)	3.34 (84.84)	12 (304.80)	0.016 (.41)	3.15 (80.01)
FH-250-18-2ISO	ISO-63	2 1/2 (63.50)	3.34 (84.84)	18 (457.20)	0.016 (.41)	3.15 (80.01)
FH-250-20-2ISO	ISO-63	2 1/2 (63.50)	3.34 (84.84)	20 (508.00)	0.016 (.41)	3.15 (80.01)
FH-250-24-2ISO	ISO-63	2 1/2 (63.50)	3.34 (84.84)	24 (609.60)	0.016 (.41)	3.15 (80.01)
FH-250-36-2ISO	ISO-63	2 1/2 (63.50)	3.34 (84.84)	36 (914.40)	0.016 (.41)	3.15 (80.01)
FH-250-40-2ISO	ISO-63	3 (76.20)	3.99 (101.35)	40 (1016.00)	0.016 (.41)	3.15 (80.01)
FH-300-10-2ISO	ISO-80	3 (76.20)	3.99 (101.35)	10 (254.00)	0.016 (.41)	3.82 (97.03)
FH-300-12-2ISO	ISO-80	3 (76.20)	3.99 (101.35)	12 (304.80)	0.016 (.41)	3.82 (97.03)
FH-300-18-2ISO	ISO-80	3 (76.20)	3.99 (101.35)	18 (457.20)	0.016 (.41)	3.82 (97.03)
FH-300-20-2ISO	ISO-80	3 (76.20)	3.99 (101.35)	20 (508.00)	0.016 (.41)	3.82 (97.03)
FH-300-24-2ISO	ISO-80	3 (76.20)	3.99 (101.35)	24 (609.60)	0.016 (.41)	3.82 (97.03)
FH-300-36-2ISO	ISO-80	3 (76.20)	3.99 (101.35)	36 (914.40)	0.016 (.41)	3.82 (97.03)
FH-300-40-2ISO	ISO-80	4 (101.60)	4.83 (122.68)	40 (1016.00)	0.016 (.41)	3.82 (97.03)
FH-400-10-2ISO	ISO-100	4 (101.60)	4.83 (122.68)	10 (254.00)	0.016 (.41)	4.45 (113.03)
FH-400-12-2ISO	ISO-100	4 (101.60)	4.83 (122.68)	12 (304.80)	0.016 (.41)	4.45 (113.03)
FH-400-18-2ISO	ISO-100	4 (101.60)	4.83 (122.68)	18 (457.20)	0.016 (.41)	4.45 (113.03)
FH-400-20-2ISO	ISO-100	4 (101.60)	4.83 (122.68)	20 (508.00)	0.016 (.41)	4.45 (113.03)
FH-400-24-2ISO	ISO-100	4 (101.60)	4.83 (122.68)	24 (609.60)	0.016 (.41)	4.45 (113.03)
FH-400-36-2ISO	ISO-100	4 (101.60)	4.83 (122.68)	36 (914.40)	0.016 (.41)	4.45 (113.03)
FH-400-40-2ISO	ISO-100	4 (101.60)	4.83 (122.68)	40 (1016.00)	0.016 (.41)	4.45 (113.03)

SPECIFICATIONS

Nominal ID sizes: 3/4 to 4 inch (19.05-101.6mm)

Materials

Hose: 321 stainless steel
 Tube ends: 304 stainless steel
 Flanges: 304 stainless steel
 (316L available on request)

Vacuum Range

Metal seal: $\geq 1 \times 10^{-10}$ mbar - UHV
 Elastomer seal: $\geq 1 \times 10^{-8}$ mbar - High vacuum

Temperature Range

Metal seal: -200°C to 450°C
 Elastomer seal: -20°C to 150°C

Options: Protective braided sleeving

ISO Flexible Stainless Steel Hoses – Thick Wall

MODEL NUMBER	FLANGE TYPE	NOMINAL ID	HOSE OD	OVERALL LENGTH	WALL THICKNESS	STATIC BEND RADIUS
TH-250-20-2ISO	ISO-63	2 1/2 (63.50)	3.10 (78.74)	20 (508.00)	0.020 (.51)	8.00 (203.20)
TH-250-40-2ISO	ISO-63	2 1/2 (63.50)	3.10 (78.74)	40 (1016.00)	0.020 (.51)	8.00 (203.20)
TH-300-20-2ISO	ISO-80	3 (76.20)	3.92 (99.57)	20 (508.00)	0.020 (.51)	9.00 (228.60)
TH-300-40-2ISO	ISO-80	3 (76.20)	3.92 (99.57)	40 (1016.00)	0.020 (.51)	9.00 (228.60)
TH-400-20-2ISO	ISO-100	4 (101.60)	4.82 (122.43)	20 (508.00)	0.020 (.51)	13.00 (330.20)
TH-400-40-2ISO	ISO-100	4 (101.60)	4.82 (122.43)	40 (1016.00)	0.020 (.51)	13.00 (330.20)

Flexible Hoses & Couplings

Flexible Stainless Steel Hoses



CF Flexible Stainless Steel Hoses

MODEL NUMBER	NOMINAL ID	HOSE OD	OVERALL LENGTH	FLANGE OD	WALL THICKNESS	STATIC BEND RADIUS
FH-075-12-2CF	¾ (19.05)	1.11 (28.19)	12 (304.80)	1.33 (33.78)	0.008 (.20)	1.26 (32.00)
FH-075-18-2CF	¾ (19.05)	1.11 (28.19)	18 (547.20)	1.33 (33.78)	0.008 (.20)	1.26 (32.00)
FH-075-24-2CF	¾ (19.05)	1.11 (28.19)	24 (609.60)	1.33 (33.78)	0.008 (.20)	1.26 (32.00)
FH-075-36-2CF	¾ (19.05)	1.11 (28.19)	36 (914.40)	1.33 (33.78)	0.008 (.20)	1.26 (32.00)
FH-100-12-2CF	1 (25.40)	1.37 (34.80)	12 (304.80)	2.12 (53.85)	0.008 (.20)	1.46 (37.08)
FH-100-18-2CF	1 (25.40)	1.37 (34.80)	18 (547.20)	2.12 (53.85)	0.008 (.20)	1.46 (37.08)
FH-100-24-2CF	1 (25.40)	1.37 (34.80)	24 (609.60)	2.12 (53.85)	0.008 (.20)	1.46 (37.08)
FH-100-36-2CF	1 (25.40)	1.37 (34.80)	36 (914.40)	2.12 (53.85)	0.008 (.20)	1.46 (37.08)
FH-150-12-2CF	1½ (38.10)	2.06 (52.32)	12 (304.80)	2.75 (69.85)	0.010 (.25)	2.16 (54.86)
FH-150-18-2CF	1½ (38.10)	2.06 (52.32)	18 (547.20)	2.75 (69.85)	0.010 (.25)	2.16 (54.86)
FH-150-24-2CF	1½ (38.10)	2.06 (52.32)	24 (609.60)	2.75 (69.85)	0.010 (.25)	2.16 (54.86)
FH-150-36-2CF	1½ (38.10)	2.06 (52.32)	36 (914.40)	2.75 (69.85)	0.010 (.25)	2.16 (54.86)
FH-200-12-2CF	2 (50.80)	2.55 (64.77)	12 (304.80)	3.38 (85.85)	0.012 (.30)	3.50 (88.90)
FH-200-18-2CF	2 (50.80)	2.55 (64.77)	18 (547.20)	3.38 (85.85)	0.012 (.30)	3.50 (88.90)
FH-200-24-2CF	2 (50.80)	2.55 (64.77)	24 (609.60)	3.38 (85.85)	0.012 (.30)	3.50 (88.90)
FH-200-36-2CF	2 (50.80)	2.55 (64.77)	36 (914.40)	3.38 (85.85)	0.012 (.30)	3.50 (88.90)
FH-250-12-2CF	2½ (63.50)	3.34 (84.84)	12 (304.80)	4.50 (114.30)	0.016 (.41)	4.25 (107.95)
FH-250-18-2CF	2½ (63.50)	3.34 (84.84)	18 (547.20)	4.50 (114.30)	0.016 (.41)	4.25 (107.95)
FH-250-24-2CF	2½ (63.50)	3.34 (84.84)	24 (609.60)	4.50 (114.30)	0.016 (.41)	4.25 (107.95)
FH-250-36-2CF	2½ (63.50)	3.34 (84.84)	36 (914.40)	4.50 (114.30)	0.016 (.41)	4.25 (107.95)
FH-300-12-2CF	3 (76.20)	3.99 (101.35)	12 (304.80)	4.62 (117.35)	0.016 (.41)	6.00 (152.40)
FH-300-18-2CF	3 (76.20)	3.99 (101.35)	18 (547.20)	4.62 (117.35)	0.016 (.41)	6.00 (152.40)
FH-300-24-2CF	3 (76.20)	3.99 (101.35)	24 (609.60)	4.62 (117.35)	0.016 (.41)	6.00 (152.40)
FH-300-36-2CF	3 (76.20)	3.99 (101.35)	36 (914.40)	4.62 (117.35)	0.016 (.41)	6.00 (152.40)
FH-400-12-2CF	4 (101.60)	4.83 (122.68)	12 (304.80)	6.00 (152.40)	0.016 (.41)	8.60 (218.44)
FH-400-18-2CF	4 (101.60)	4.83 (122.68)	18 (547.20)	6.00 (152.40)	0.016 (.41)	8.60 (218.44)
FH-400-24-2CF	4 (101.60)	4.83 (122.68)	24 (609.60)	6.00 (152.40)	0.016 (.41)	8.60 (218.44)
FH-400-36-2CF	4 (101.60)	4.83 (122.68)	36 (914.40)	6.00 (152.40)	0.016 (.41)	8.60 (218.44)

Note: See Braided Hose selection next page.

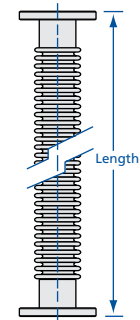
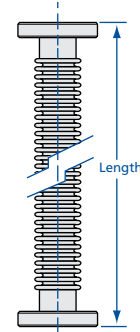

ASA Flexible Stainless Steel Hoses

MODEL NUMBER	DESCRIPTION	NOMINAL ID	HOSE OD	OVERALL LENGTH	WALL THICKNESS	STATIC BEND RADIUS
FH-250-12-ASA	ASA-5 on one port	2½ (63.50)	3.34 (84.84)	12 (304.80)	0.016 (.41)	4.25 (107.95)
FH-250-12-2ASA	ASA-5 on both ports	2½ (63.50)	3.34 (84.84)	12 (304.80)	0.016 (.41)	4.25 (107.95)
FH-250-18-ASA	ASA-5 on one port	2½ (63.50)	3.34 (84.84)	18 (457.20)	0.016 (.41)	4.25 (107.95)
FH-250-18-2ASA	ASA-5 on both ports	2½ (63.50)	3.34 (84.84)	18 (457.20)	0.016 (.41)	4.25 (107.95)
FH-250-24-ASA	ASA-5 on one port	2½ (63.50)	3.34 (84.84)	24 (609.60)	0.016 (.41)	4.25 (107.95)
FH-250-24-2ASA	ASA-5 on both ports	2½ (63.50)	3.34 (84.84)	24 (609.60)	0.016 (.41)	4.25 (107.95)
FH-250-36-ASA	ASA-5 on one port	2½ (63.50)	3.34 (84.84)	36 (914.40)	0.016 (.41)	4.25 (107.95)
FH-250-36-2ASA	ASA-5 on both ports	2½ (63.50)	3.34 (84.84)	36 (914.40)	0.016 (.41)	4.25 (107.95)
FH-300-12-ASA	ASA-6 on one port	3 (76.20)	3.99 (101.35)	12 (304.80)	0.016 (.41)	6.00 (152.40)
FH-300-12-2ASA	ASA-6 on both ports	3 (76.20)	3.99 (101.35)	12 (304.80)	0.016 (.41)	6.00 (152.40)
FH-300-18-ASA	ASA-6 on one port	3 (76.20)	3.99 (101.35)	18 (457.20)	0.016 (.41)	6.00 (152.40)
FH-300-18-2ASA	ASA-6 on both ports	3 (76.20)	3.99 (101.35)	18 (457.20)	0.016 (.41)	6.00 (152.40)
FH-300-24-ASA	ASA-6 on one port	3 (76.20)	3.99 (101.35)	24 (609.60)	0.016 (.41)	6.00 (152.40)
FH-300-24-2ASA	ASA-6 on both ports	3 (76.20)	3.99 (101.35)	24 (609.60)	0.016 (.41)	6.00 (152.40)
FH-300-36-ASA	ASA-6 on one port	3 (76.20)	3.99 (101.35)	36 (914.40)	0.016 (.41)	6.00 (152.40)
FH-300-36-2ASA	ASA-6 on both ports	3 (76.20)	3.99 (101.35)	36 (914.40)	0.016 (.41)	6.00 (152.40)
FH-400-12-ASA	ASA-7.5 on one port	4 (101.60)	4.83 (122.68)	12 (304.80)	0.016 (.41)	8.60 (218.44)
FH-400-12-2ASA	ASA-7.5 on both ports	4 (101.60)	4.83 (122.68)	12 (304.80)	0.016 (.41)	8.60 (218.44)
FH-400-18-ASA	ASA-7.5 on one port	4 (101.60)	4.83 (122.68)	18 (457.20)	0.016 (.41)	8.60 (218.44)
FH-400-18-2ASA	ASA-7.5 on both ports	4 (101.60)	4.83 (122.68)	18 (457.20)	0.016 (.41)	8.60 (218.44)
FH-400-24-ASA	ASA-7.5 on one port	4 (101.60)	4.83 (122.68)	24 (609.60)	0.016 (.41)	8.60 (218.44)
FH-400-24-2ASA	ASA-7.5 on both ports	4 (101.60)	4.83 (122.68)	24 (609.60)	0.016 (.41)	8.60 (218.44)
FH-400-36-ASA	ASA-7.5 on one port	4 (101.60)	4.83 (122.68)	36 (914.40)	0.016 (.41)	8.60 (218.44)
FH-400-36-2ASA	ASA-7.5 on both ports	4 (101.60)	4.83 (122.68)	36 (914.40)	0.016 (.41)	8.60 (218.44)

Note: Call for O-ring groove pricing if required

All dimensions are in inches (mm) & weights are in pounds (kg), unless otherwise noted.

Flexible Hoses & Couplings

Braided Stainless Steel Flexible Hoses

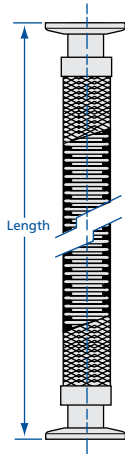

NW Flexible Stainless Steel Braided Hoses

MODEL NUMBER	FLANGE TYPE	NOMINAL ID	HOSE OD	OVERALL LENGTH	WALL THICKNESS	STATIC BEND RADIUS
FHB-075-12-2NW	NW-16	3/4 (19.05)	1 1/4 (31.75)	12 (304.80)	0.008 (.20)	2.09 (53.09)
FHB-075-18-2NW	NW-16	3/4 (19.05)	1 1/4 (31.75)	18 (457.20)	0.008 (.20)	2.09 (53.09)
FHB-075-20-2NW	NW-16	3/4 (19.05)	1 1/4 (31.75)	20 (508.00)	0.008 (.20)	2.09 (53.09)
FHB-075-24-2NW	NW-16	3/4 (19.05)	1 1/4 (31.75)	24 (609.60)	0.008 (.20)	2.09 (53.09)
FHB-075-36-2NW	NW-16	3/4 (19.05)	1 1/4 (31.75)	36 (914.40)	0.008 (.20)	2.09 (53.09)
FHB-075-40-2NW	NW-16	3/4 (19.05)	1 1/4 (31.75)	40 (1016.00)	0.008 (.20)	2.09 (53.09)
FHB-100-12-2NW	NW-25	1 (25.40)	1 5/8 (41.28)	12 (304.80)	0.008 (.20)	2.52 (64.01)
FHB-100-18-2NW	NW-25	1 (25.40)	1 5/8 (41.28)	18 (457.20)	0.008 (.20)	2.52 (64.01)
FHB-100-20-2NW	NW-25	1 (25.40)	1 5/8 (41.28)	20 (508.00)	0.008 (.20)	2.52 (64.01)
FHB-100-24-2NW	NW-25	1 (25.40)	1 5/8 (41.28)	24 (609.60)	0.008 (.20)	2.52 (64.01)
FHB-100-36-2NW	NW-25	1 (25.40)	1 5/8 (41.28)	36 (914.40)	0.008 (.20)	2.52 (64.01)
FHB-100-40-2NW	NW-25	1 (25.40)	1 5/8 (41.28)	40 (1016.00)	0.008 (.20)	2.52 (64.01)
FHB-150-12-2NW	NW-40	1 1/2 (38.10)	2 1/4 (57.15)	12 (304.80)	0.010 (.25)	3.86 (98.04)
FHB-150-18-2NW	NW-40	1 1/2 (38.10)	2 1/4 (57.15)	18 (457.20)	0.010 (.25)	3.86 (98.04)
FHB-150-20-2NW	NW-40	1 1/2 (38.10)	2 1/4 (57.15)	20 (508.00)	0.010 (.25)	3.86 (98.04)
FHB-150-24-2NW	NW-40	1 1/2 (38.10)	2 1/4 (57.15)	24 (609.60)	0.010 (.25)	3.86 (98.04)
FHB-150-36-2NW	NW-40	1 1/2 (38.10)	2 1/4 (57.15)	36 (914.40)	0.010 (.25)	3.86 (98.04)
FHB-150-40-2NW	NW-40	1 1/2 (38.10)	2 1/4 (57.15)	40 (1016.00)	0.010 (.25)	3.86 (98.04)
FHB-200-12-2NW	NW-50	2 (50.80)	2 3/4 (69.85)	12 (304.80)	0.012 (.30)	4.72 (119.89)
FHB-200-18-2NW	NW-50	2 (50.80)	2 3/4 (69.85)	18 (457.20)	0.012 (.30)	4.72 (119.89)
FHB-200-20-2NW	NW-50	2 (50.80)	2 3/4 (69.85)	20 (508.00)	0.012 (.30)	4.72 (119.89)
FHB-200-24-2NW	NW-50	2 (50.80)	2 3/4 (69.85)	24 (609.60)	0.012 (.30)	4.72 (119.89)
FHB-200-36-2NW	NW-50	2 (50.80)	2 3/4 (69.85)	36 (914.40)	0.012 (.30)	4.72 (119.89)
FHB-200-40-2NW	NW-50	2 (50.80)	2 3/4 (69.85)	40 (1016.00)	0.012 (.30)	4.72 (119.89)

CF Flexible Stainless Steel Braided Hoses

MODEL NUMBER	NOMINAL ID	HOSE OD	OVERALL LENGTH	FLANGE OD	WALL THICKNESS	STATIC BEND RADIUS
FHB-075-12-2CF	3/4 (19.05)	1 1/4 (31.75)	12 (304.80)	1.33 (33.78)	0.008 (.20)	2.09 (53.09)
FHB-075-18-2CF	3/4 (19.05)	1 1/4 (31.75)	18 (457.20)	1.33 (33.78)	0.008 (.20)	2.09 (53.09)
FHB-075-24-2CF	3/4 (19.05)	1 1/4 (31.75)	24 (609.60)	1.33 (33.78)	0.008 (.20)	2.09 (53.09)
FHB-075-36-2CF	3/4 (19.05)	1 1/4 (31.75)	36 (914.40)	1.33 (33.78)	0.008 (.20)	2.09 (53.09)
FHB-100-12-2CF	1 (25.40)	1 5/8 (41.28)	12 (304.80)	2.12 (53.85)	0.008 (.20)	2.52 (64.01)
FHB-100-18-2CF	1 (25.40)	1 5/8 (41.28)	18 (457.20)	2.12 (53.85)	0.008 (.20)	2.52 (64.01)
FHB-100-24-2CF	1 (25.40)	1 5/8 (41.28)	24 (609.60)	2.12 (53.85)	0.008 (.20)	2.52 (64.01)
FHB-100-36-2CF	1 (25.40)	1 5/8 (41.28)	36 (914.40)	2.12 (53.85)	0.008 (.20)	2.52 (64.01)
FHB-150-12-2CF	1 1/2 (38.10)	2 1/4 (57.15)	12 (304.80)	2.75 (69.85)	0.010 (.25)	3.86 (98.04)
FHB-150-18-2CF	1 1/2 (38.10)	2 1/4 (57.15)	18 (457.20)	2.75 (69.85)	0.010 (.25)	3.86 (98.04)
FHB-150-24-2CF	1 1/2 (38.10)	2 1/4 (57.15)	24 (609.60)	2.75 (69.85)	0.010 (.25)	3.86 (98.04)
FHB-150-36-2CF	1 1/2 (38.10)	2 1/4 (57.15)	36 (914.40)	2.75 (69.85)	0.010 (.25)	3.86 (98.04)
FHB-200-12-2CF	2 (50.80)	2 3/4 (69.85)	12 (304.80)	3.38 (85.85)	0.012 (.30)	4.72 (119.89)
FHB-200-18-2CF	2 (50.80)	2 3/4 (69.85)	18 (457.20)	3.38 (85.85)	0.012 (.30)	4.72 (119.89)
FHB-200-24-2CF	2 (50.80)	2 3/4 (69.85)	24 (609.60)	3.38 (85.85)	0.012 (.30)	4.72 (119.89)
FHB-200-36-2CF	2 (50.80)	2 3/4 (69.85)	36 (914.40)	3.38 (85.85)	0.012 (.30)	4.72 (119.89)

SPECIFICATIONS

Nominal ID sizes: 3/4 to 2 inch
(19.05-50.8mm)

Materials

Bellows: 321 stainless steel
Tube ends: 304 stainless steel
Flanges: 304 stainless steel
(316L available on request)

Vacuum Range

Metal seal: $\geq 1 \times 10^{-10}$ mbar - UHV
Elastomer seal: $\geq 1 \times 10^{-8}$ mbar - High vacuum

Temperature Range

Metal seal: -200°C to 450°C
Elastomer seal: -20°C to 150°C

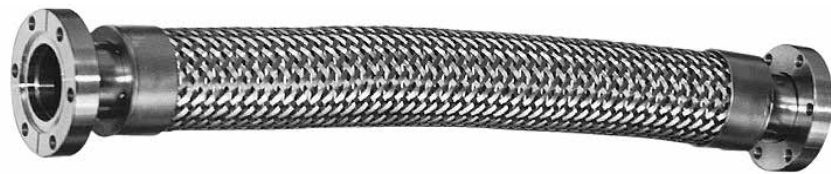

Larger hose IDs and other flange configurations available upon request.

Flexible Hoses & Couplings

PVC Flexible Hoses

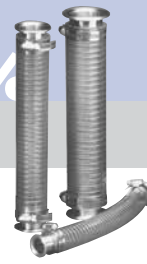

PVC Flexible Hoses

Each length includes two hose clamps for installation.

MODEL NUMBER	NOMINAL ID	HOSE OD	STATIC BEND RADIUS
PVC-050	1/2 (12.70)	0.813 (20.65)	2.00 (50.80)
PVC-075	3/4 (19.05)	1.125 (28.58)	3.00 (76.20)
PVC-100	1 (25.40)	1.375 (34.93)	4.00 (101.60)
PVC-150	1 1/2 (38.10)	2.000 (50.80)	6.00 (152.40)
PVC-200	2 (50.80)	2.500 (63.50)	8.00 (203.20)

Note: To order specify length required in feet as follows: PVC-100-5.0 and PVC-200-10.0

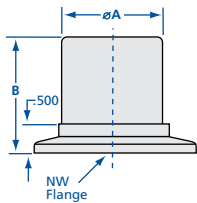
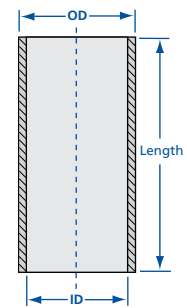

PVC Hose Nipples

MODEL NUMBER	FLANGE TYPE	NIPPLE MATERIAL	A	B
1HN-NW-10-050	NW-10	304 SS	0.50 (12.70)	1.26 (32.00)
1HN-NW-16-075	NW-16	304 SS	0.75 (19.05)	1.26 (32.00)
1HN-NW-25-100	NW-25	304 SS	1.00 (25.40)	1.50 (38.10)
1HN-NW-40-150	NW-40	304 SS	1.50 (38.10)	1.97 (50.04)
1HN-NW-50-200	NW-50	304 SS	2.00 (50.80)	2.17 (55.12)



PVC Hoses with NW Flanges

MODEL NUMBER	FLANGE TYPE	NOMINAL ID	HOSE OD	OVERALL LENGTH	STATIC BEND RADIUS
PVC-050-12-2NW	NW-10	1/2 (12.70)	0.813 (20.65)	12 (304.80)	2.00 (50.80)
PVC-050-24-2NW	NW-10	1/2 (12.70)	0.813 (20.65)	24 (609.60)	2.00 (50.80)
PVC-050-36-2NW	NW-10	1/2 (12.70)	0.813 (20.65)	36 (914.40)	2.00 (50.80)
PVC-050-72-2NW	NW-10	1/2 (12.70)	0.813 (20.65)	72 (1828.80)	2.00 (50.80)
PVC-075-12-2NW	NW-16	3/4 (19.05)	1.125 (28.58)	12 (304.80)	3.00 (76.20)
PVC-075-24-2NW	NW-16	3/4 (19.05)	1.125 (28.58)	24 (609.60)	3.00 (76.20)
PVC-075-36-2NW	NW-16	3/4 (19.05)	1.125 (28.58)	36 (914.40)	3.00 (76.20)
PVC-075-72-2NW	NW-16	3/4 (19.05)	1.125 (28.58)	72 (1828.80)	3.00 (76.20)
PVC-100-12-2NW	NW-25	1 (25.40)	1.375 (34.93)	12 (304.80)	4.00 (101.60)
PVC-100-24-2NW	NW-25	1 (25.40)	1.375 (34.93)	24 (609.60)	4.00 (101.60)
PVC-100-36-2NW	NW-25	1 (25.40)	1.375 (34.93)	36 (914.40)	4.00 (101.60)
PVC-100-72-2NW	NW-25	1 (25.40)	1.375 (34.93)	72 (1828.80)	4.00 (101.60)
PVC-150-12-2NW	NW-40	1 1/2 (38.10)	2.000 (50.80)	12 (304.80)	6.00 (152.40)
PVC-150-24-2NW	NW-40	1 1/2 (38.10)	2.000 (50.80)	24 (609.60)	6.00 (152.40)
PVC-150-36-2NW	NW-40	1 1/2 (38.10)	2.000 (50.80)	36 (914.40)	6.00 (152.40)
PVC-150-72-2NW	NW-40	1 1/2 (38.10)	2.000 (50.80)	72 (1828.80)	6.00 (152.40)
PVC-200-12-2NW	NW-50	2 (50.80)	2.500 (63.50)	12 (304.80)	8.00 (203.20)
PVC-200-24-2NW	NW-50	2 (50.80)	2.500 (63.50)	24 (609.60)	8.00 (203.20)
PVC-200-36-2NW	NW-50	2 (50.80)	2.500 (63.50)	36 (914.40)	8.00 (203.20)
PVC-200-72-2NW	NW-50	2 (50.80)	2.500 (63.50)	72 (1828.80)	8.00 (203.20)

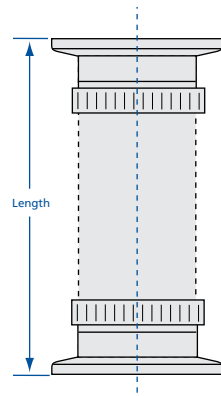

SPECIFICATIONS

Nominal ID sizes: 1/2 to 2 inch (12.7-50.8mm)

Materials

- Hose: Wire reinforced polyvinyl chloride (PVC)
- Nipples: 304 stainless steel
- Flanges: 304 stainless steel (316L available on request)

Vacuum Range: ≥1 x 10⁻² Rough vacuum

Maximum Temperature: -4° to 65°C